

NEXT-GEN LOGISTICS: POCKET SORTER

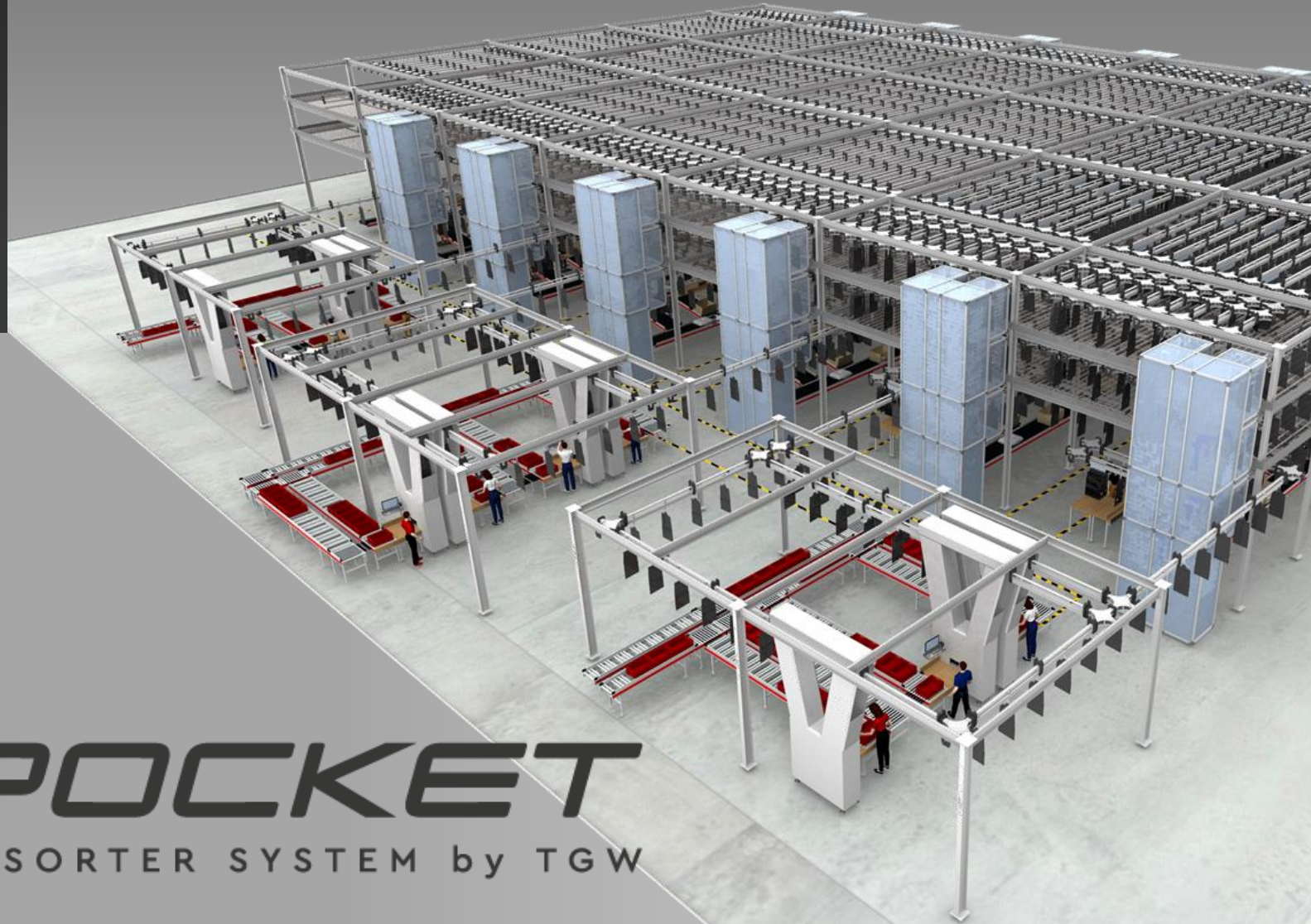

SMARTPOCKET

REVOLUTIONARY POCKET SORTER SYSTEM by TGW



quba



TEW
LIVING LOGISTICS



quba

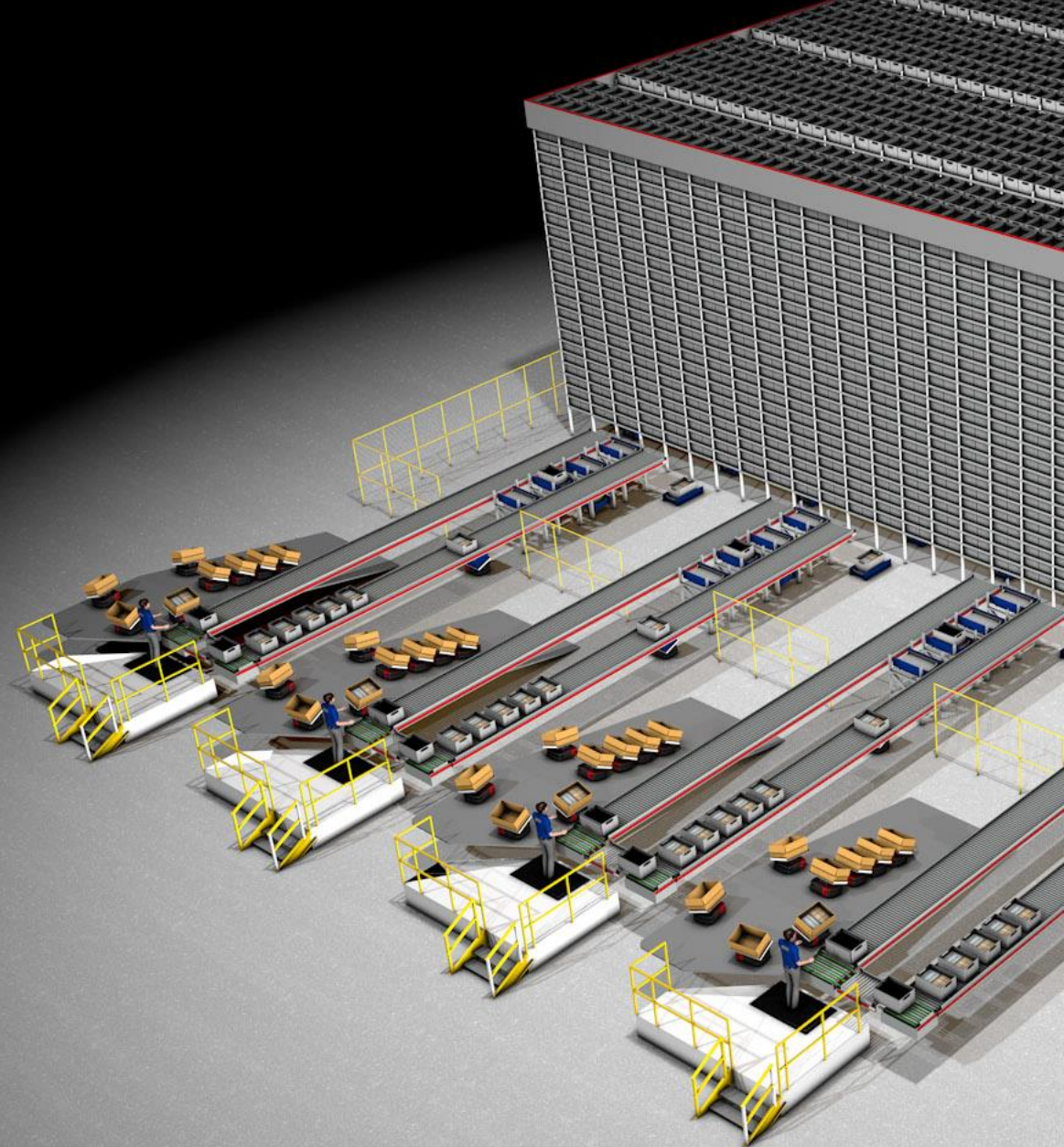

LIVEPICK[®]
ADAPTABLE ORDER FULFILMENT SYSTEM by TGW

THE CARRIER

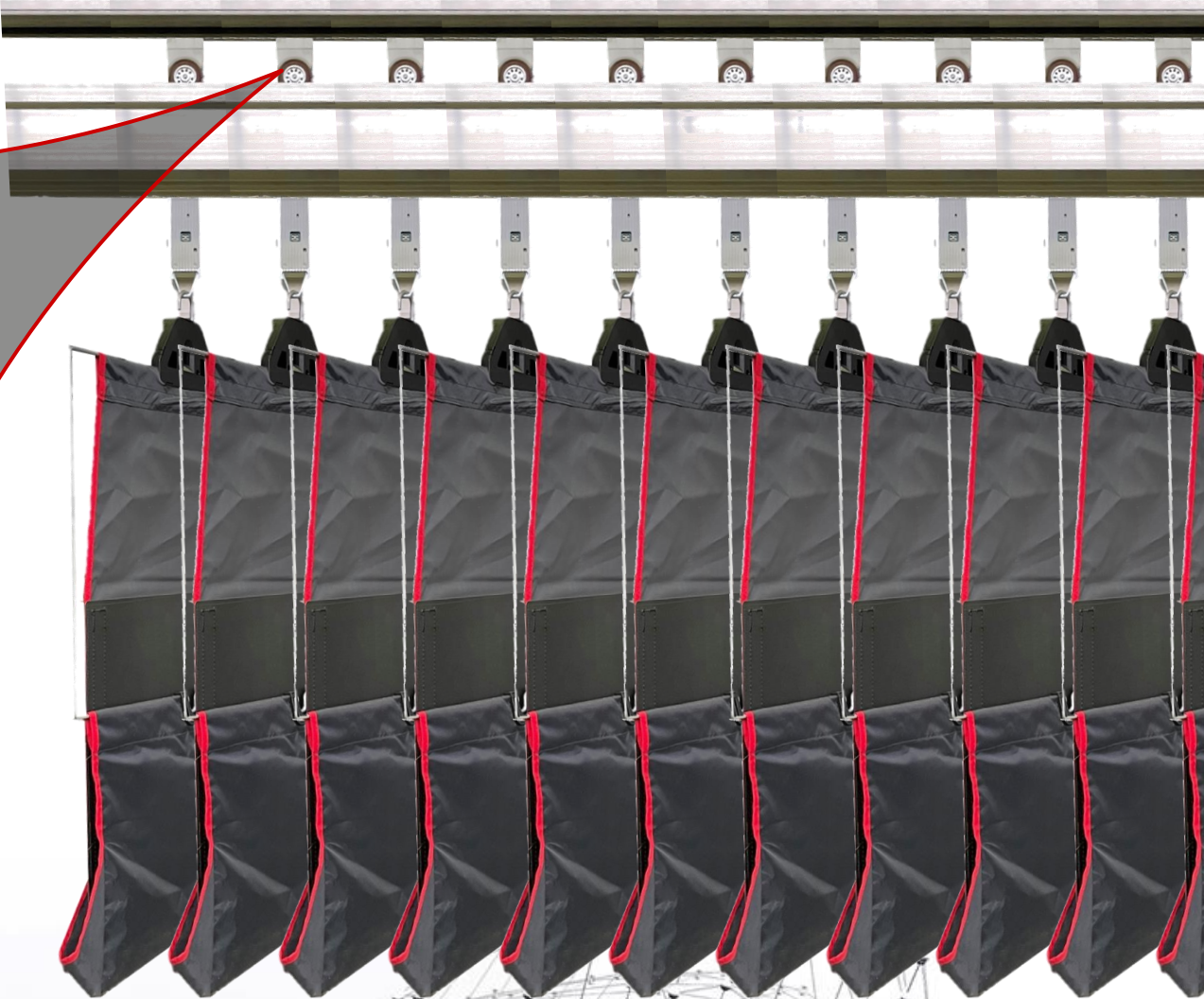
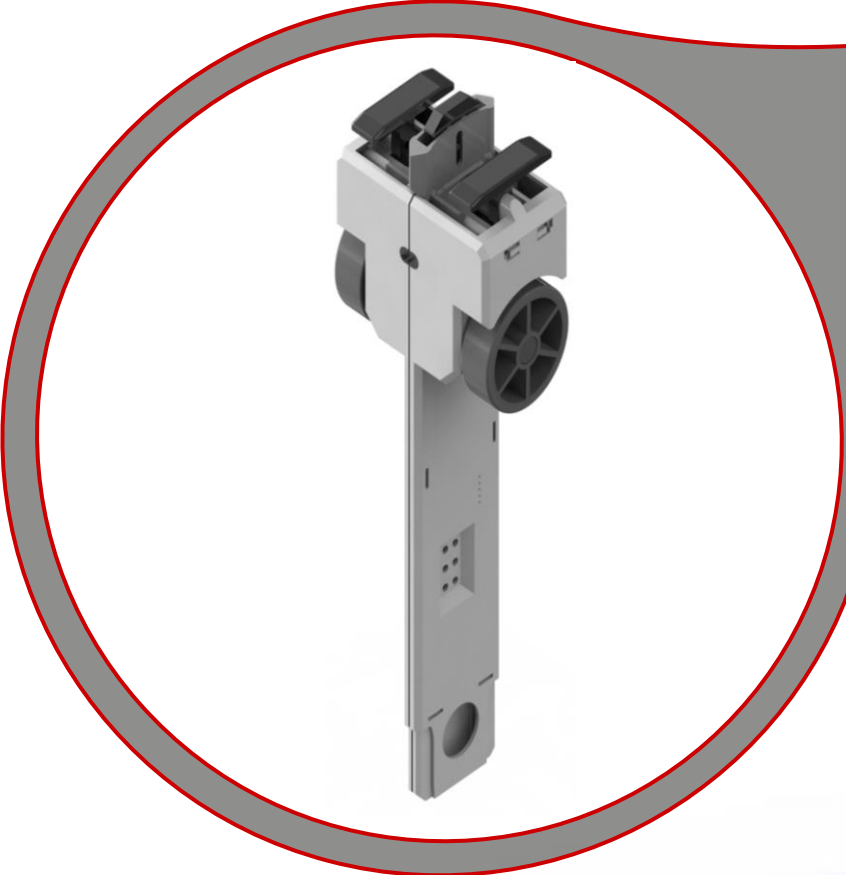

THE SYSTEM IN OPERATION



THE COMPONENTS

Carrier

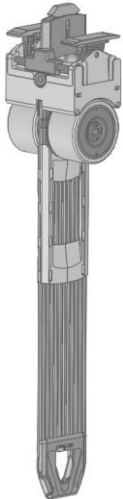

Rail

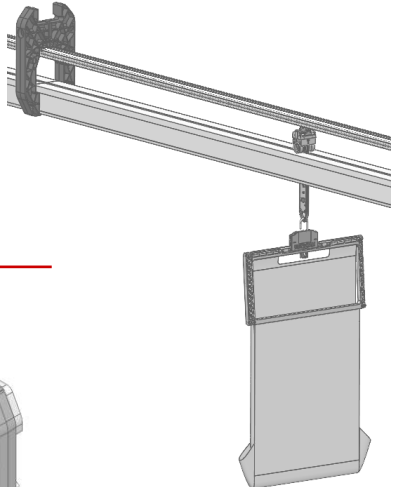

Junctions

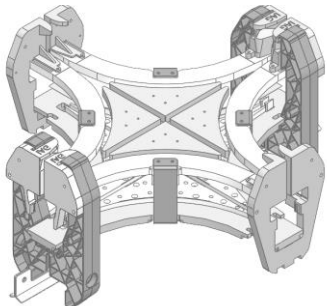

Lift

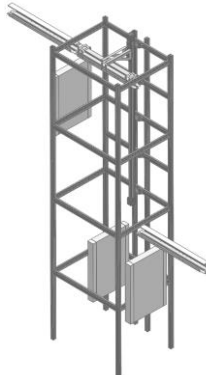

Paternoster

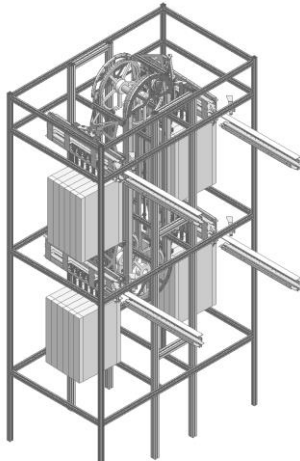

Workstations

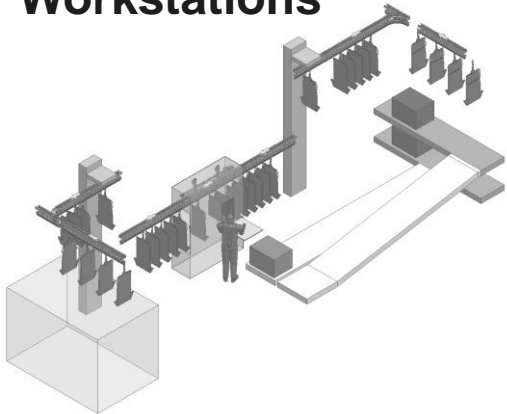

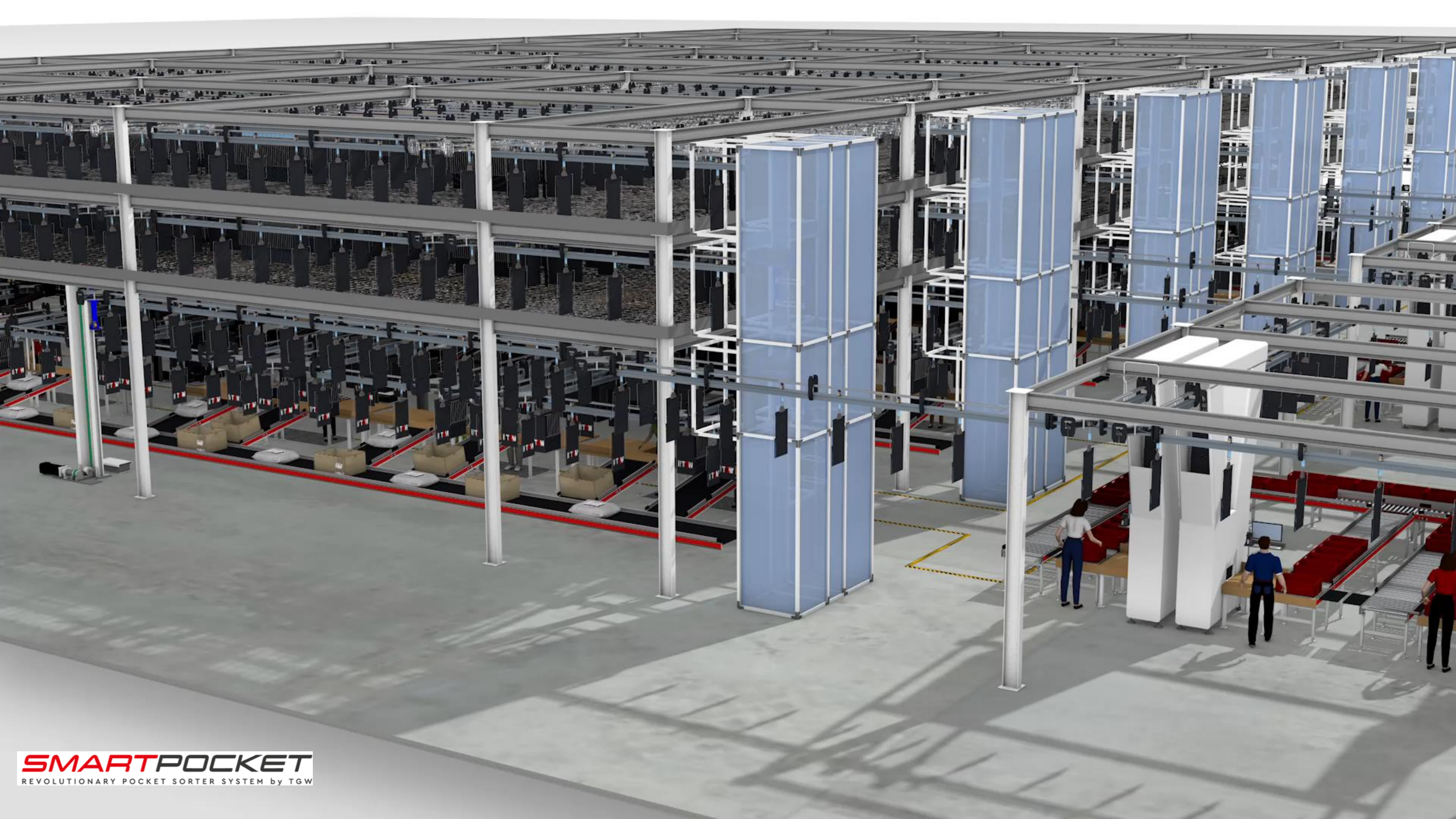

THE PROCESS

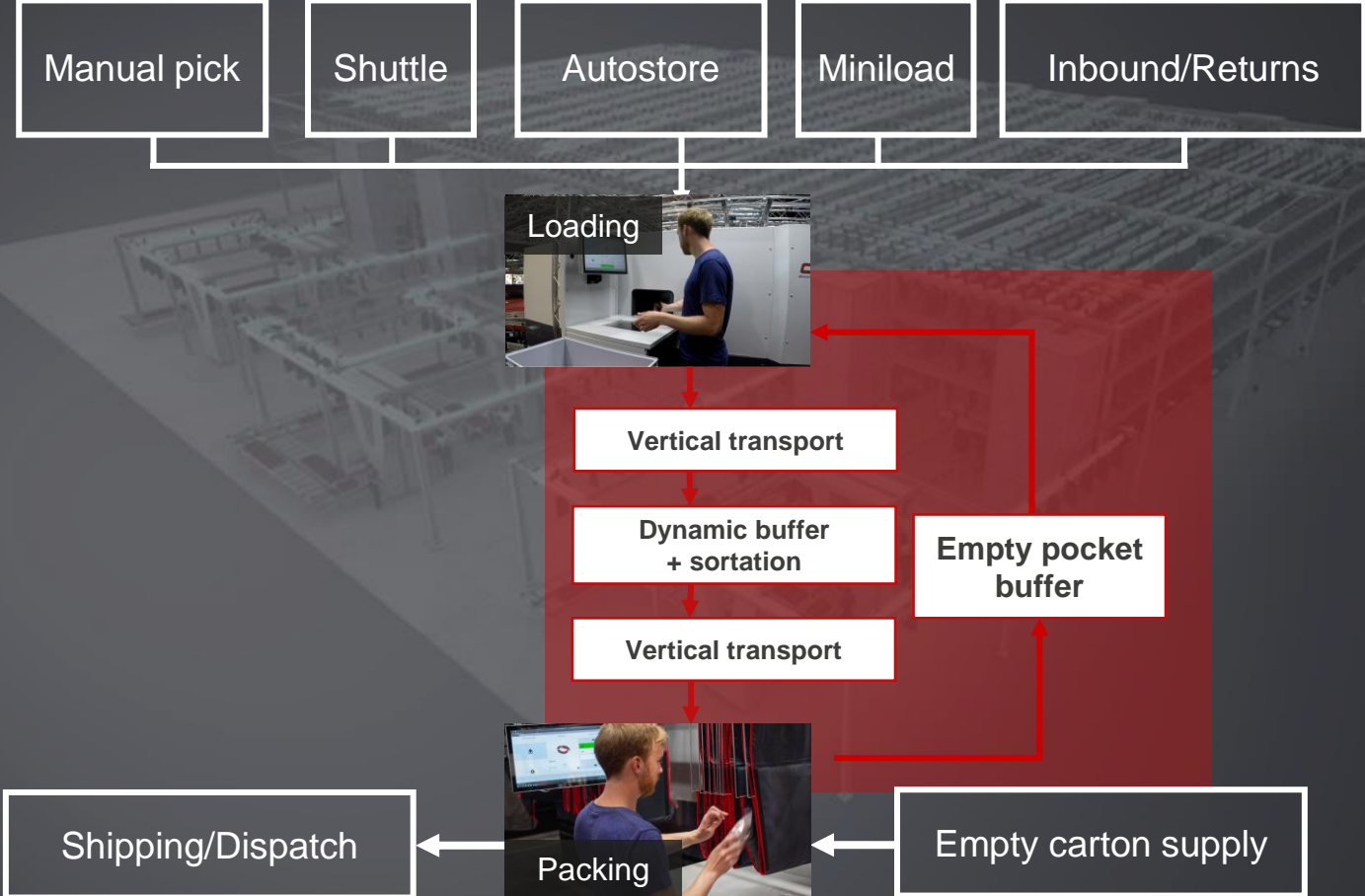

TRADITIONAL SORTATION

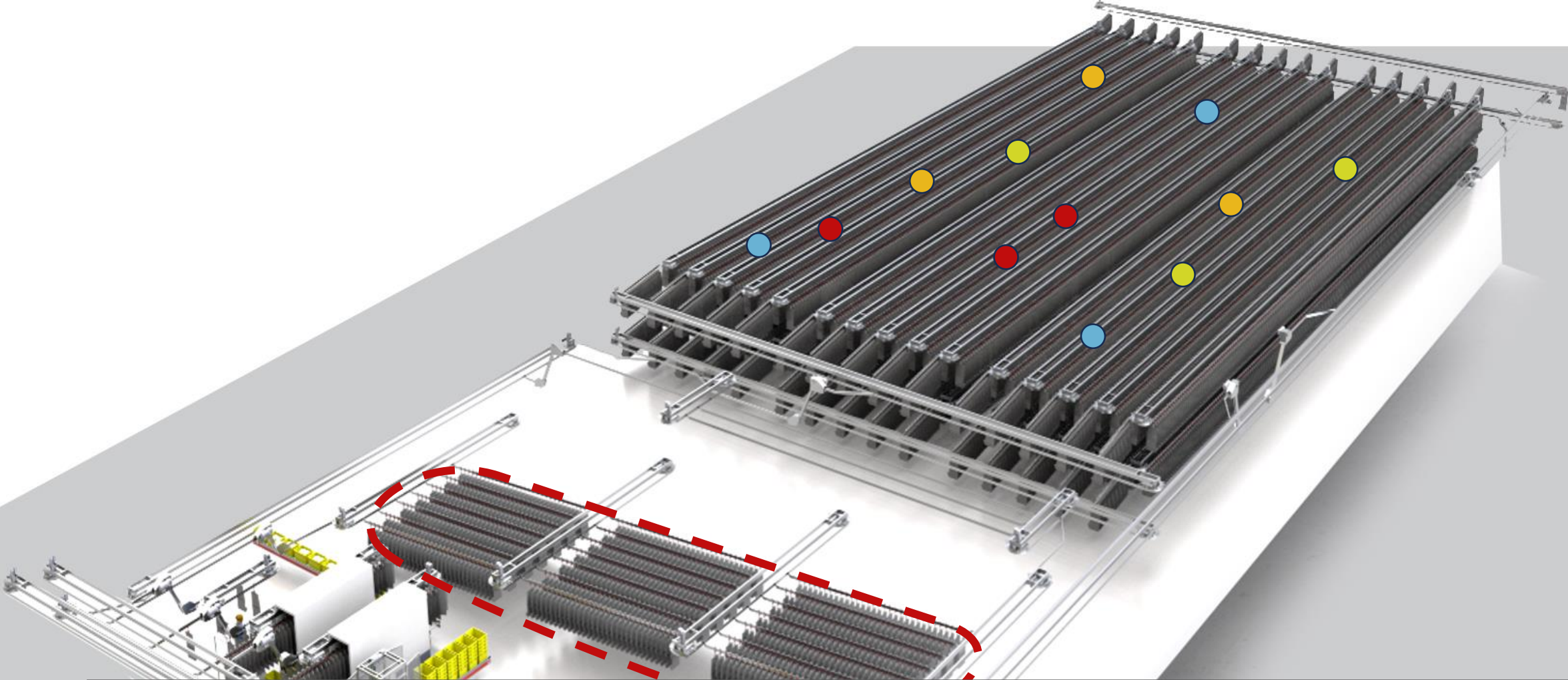

THE NEW WAY OF SORTATION

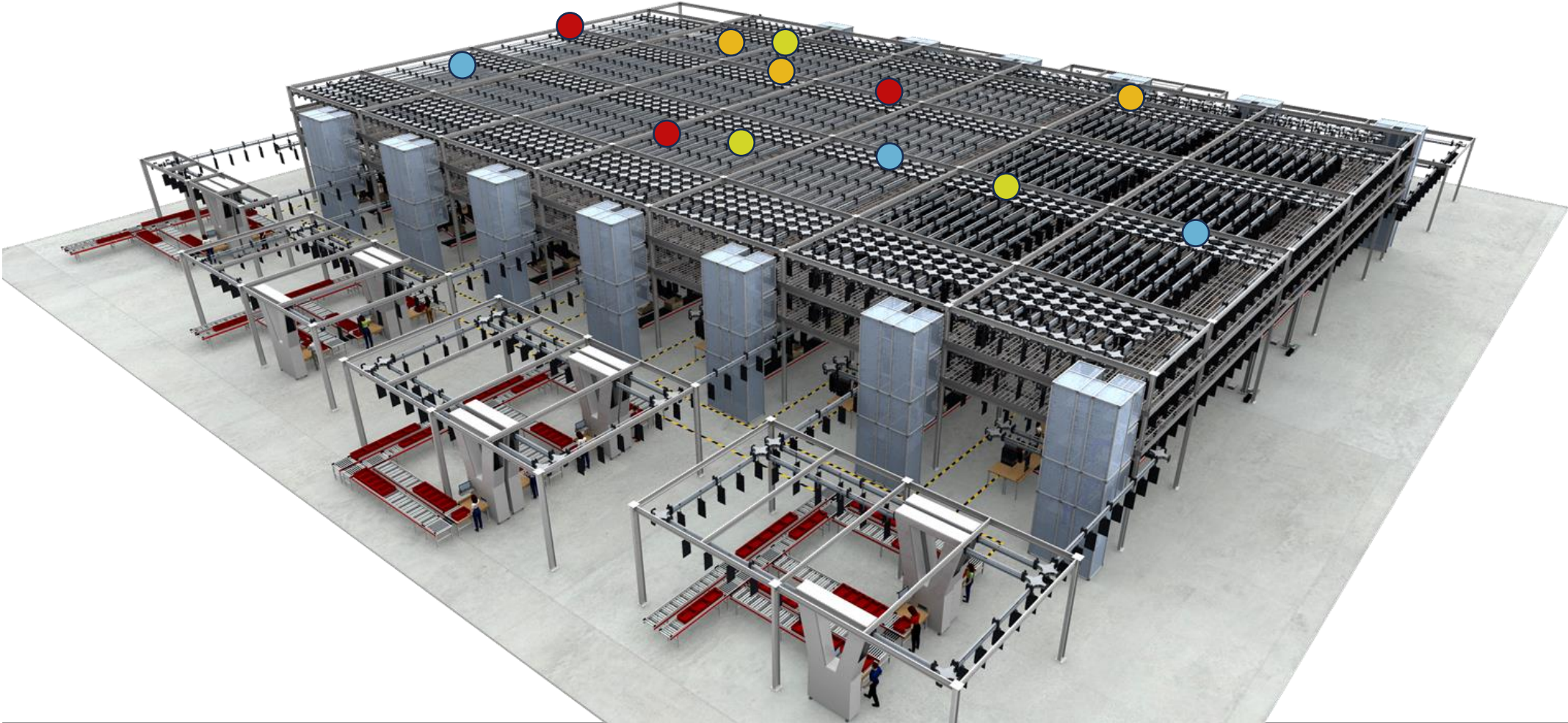

SMARTPOCKET IS BASED ON

Autonomous Mobile Robots



Mobile & relocatable



Adaptive and upgradeable



Scalable up & down



Scalable in small steps



Short order lead time
(prio orders)



High redundancy
- Decentralised processes
- No single point of failure



Fast implementation
(6 months)



Easy to maintain



Low noise



CONTACTS

SMARTPOCKET



Matthias Stötzner
Center of Competence

SZR@TGW-Group.com



Malte Beckmann
Portfolio Manager

BEJS@TGW-Group.com



BACKUP



PROFILE OF TYPICAL E-COM BUSINESS

— consumer demand

THROUGHPUT

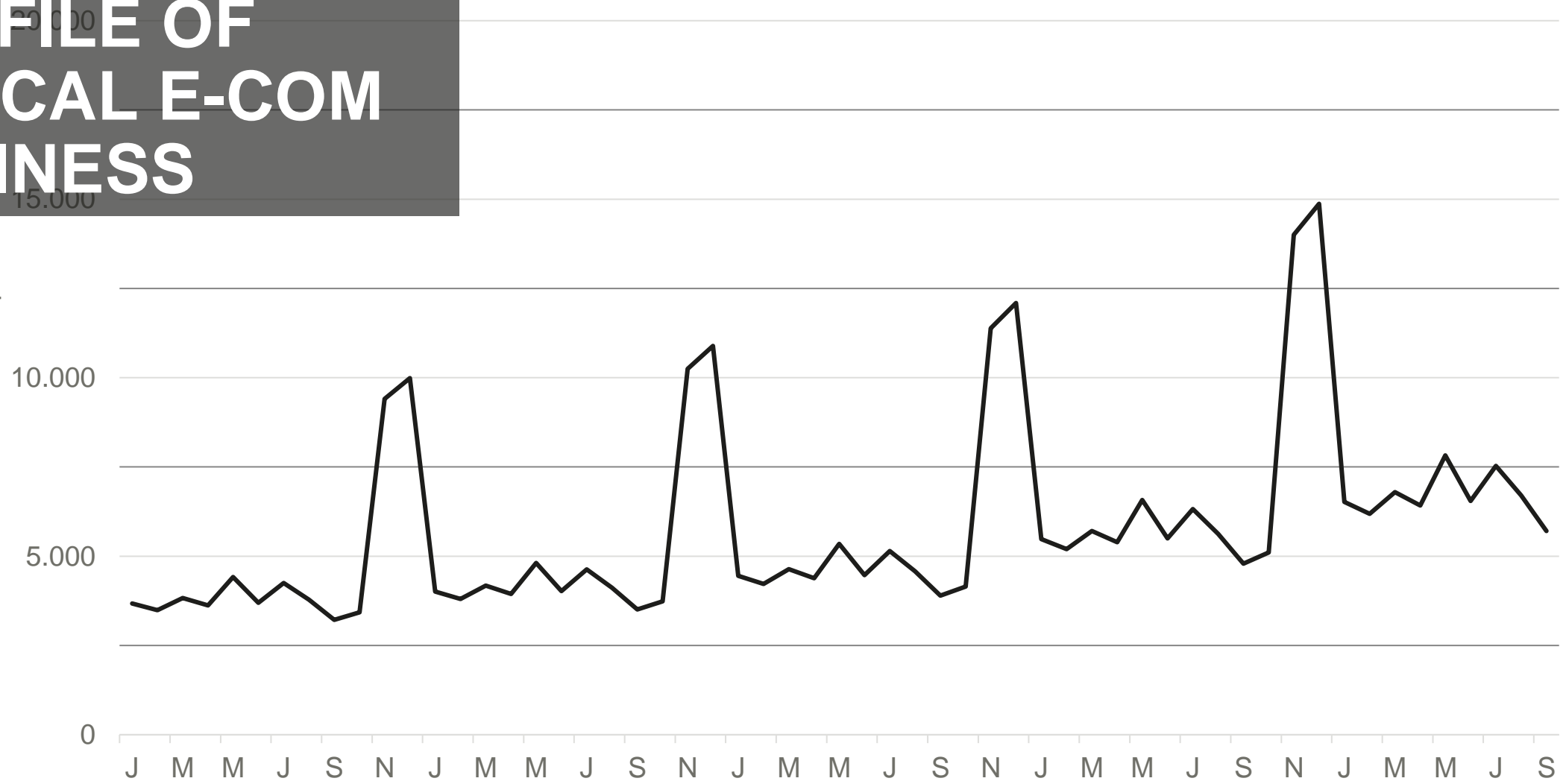

STOP PAYING FOR POTENTIAL

— consumer demand
— conventional pocket sorter

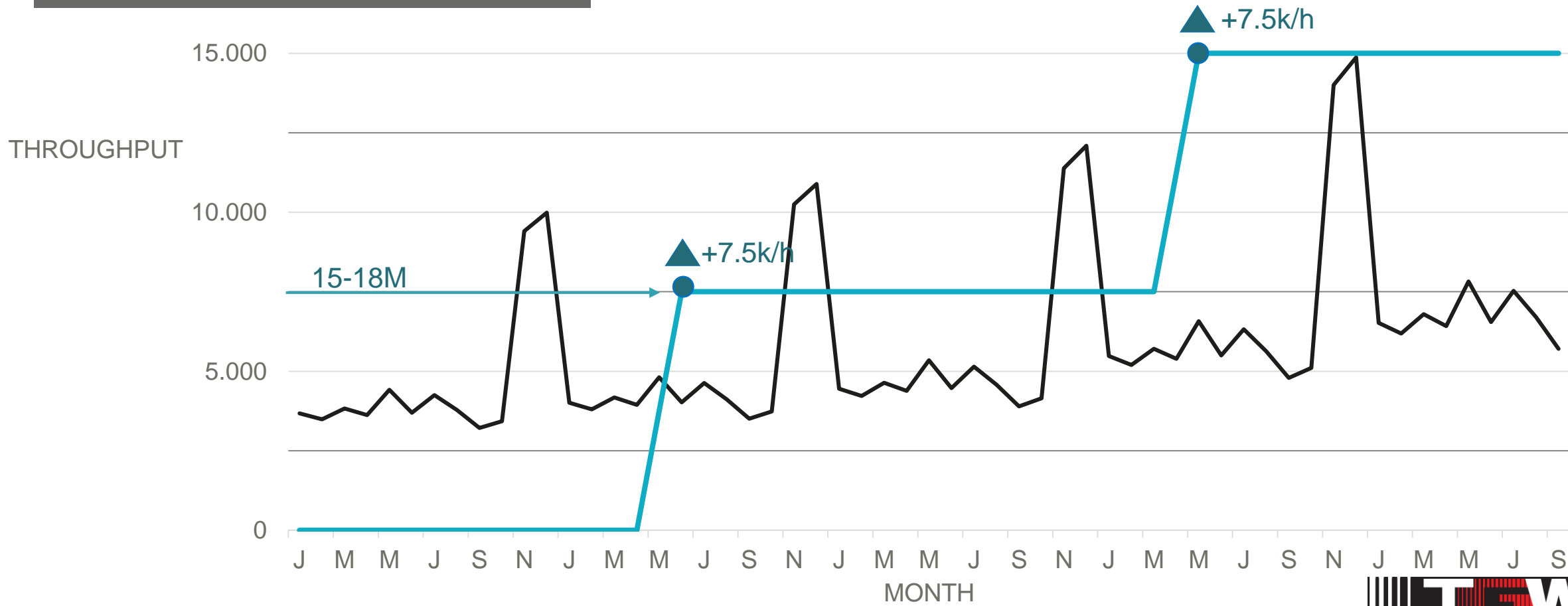

START SCALING YOUR BUSINESS

